

WAVERLY SALES TRAILER
SHEA HOMES

WAVERLY SALES TRAILER

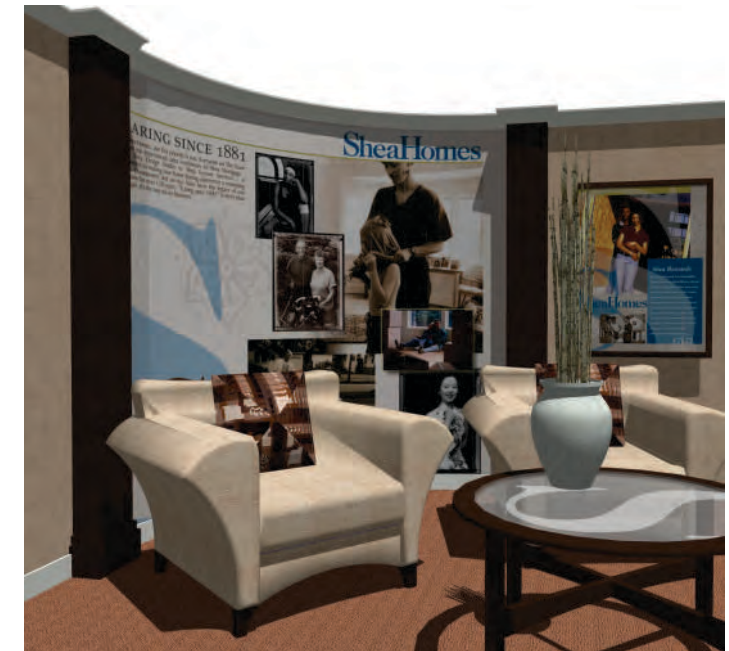

SignTech
SIGN TECHNOLOGY, INC.
JOB: WAVERLY SALES TRAILER
CLIENT: SHEA HOMES

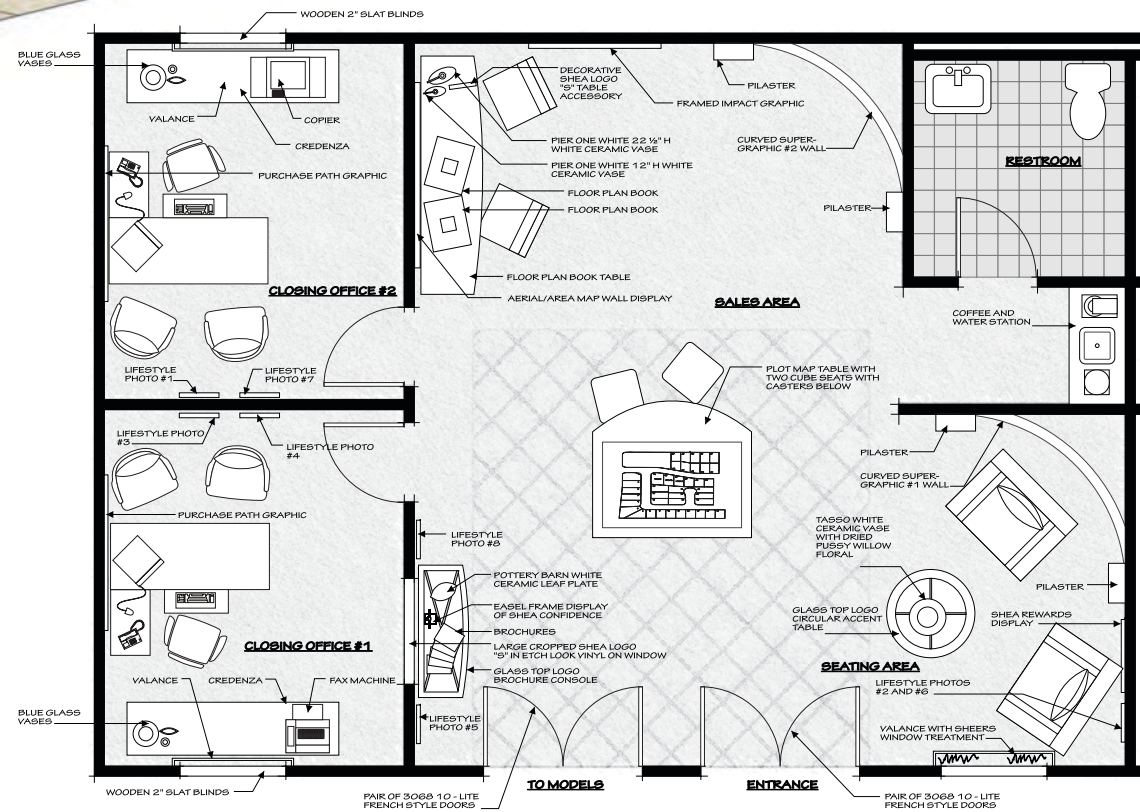

INSTALLATIONS

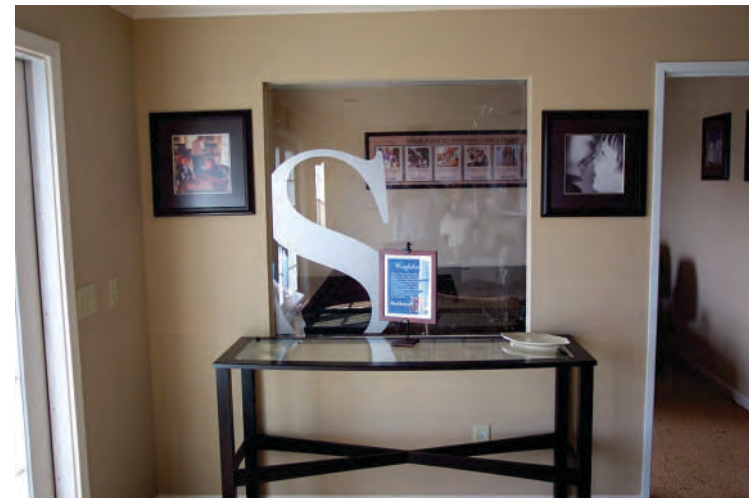
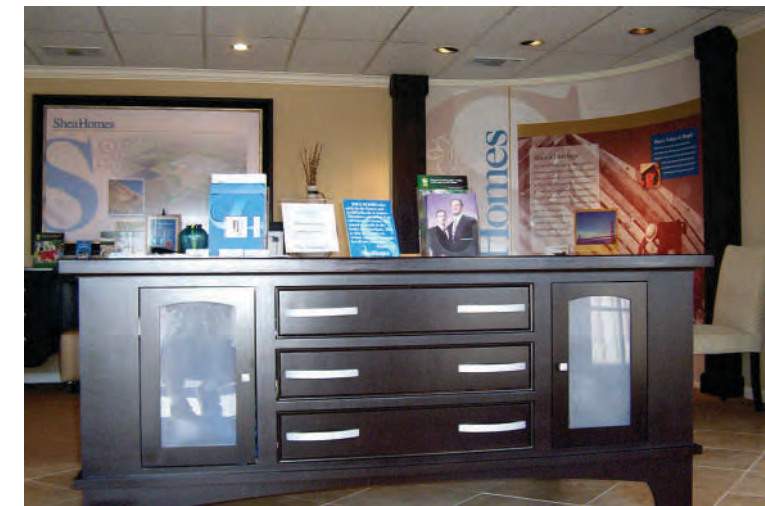

SignTech
SIGN TECHNOLOGY, INC.

JOB: WAVERLY SALES TRAILER
CLIENT: SHEA HOMES

DISPLAYS

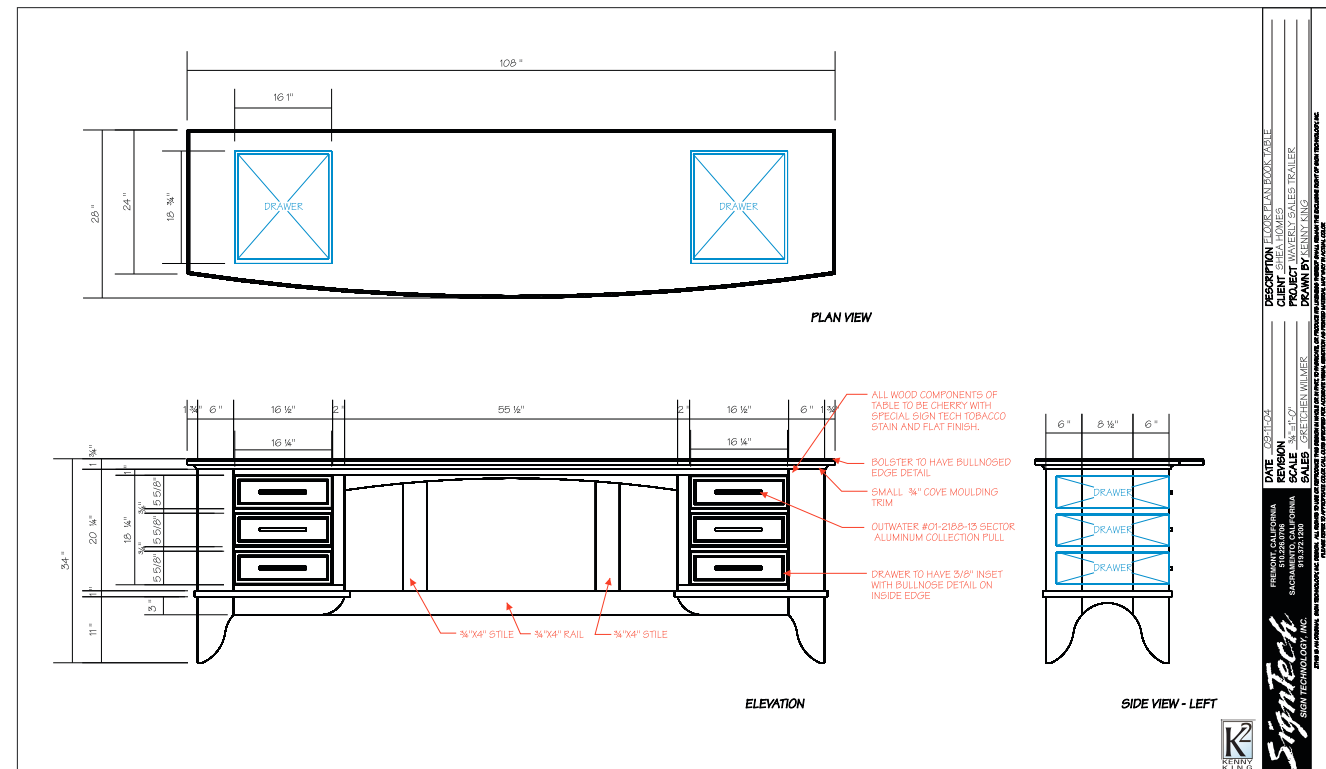
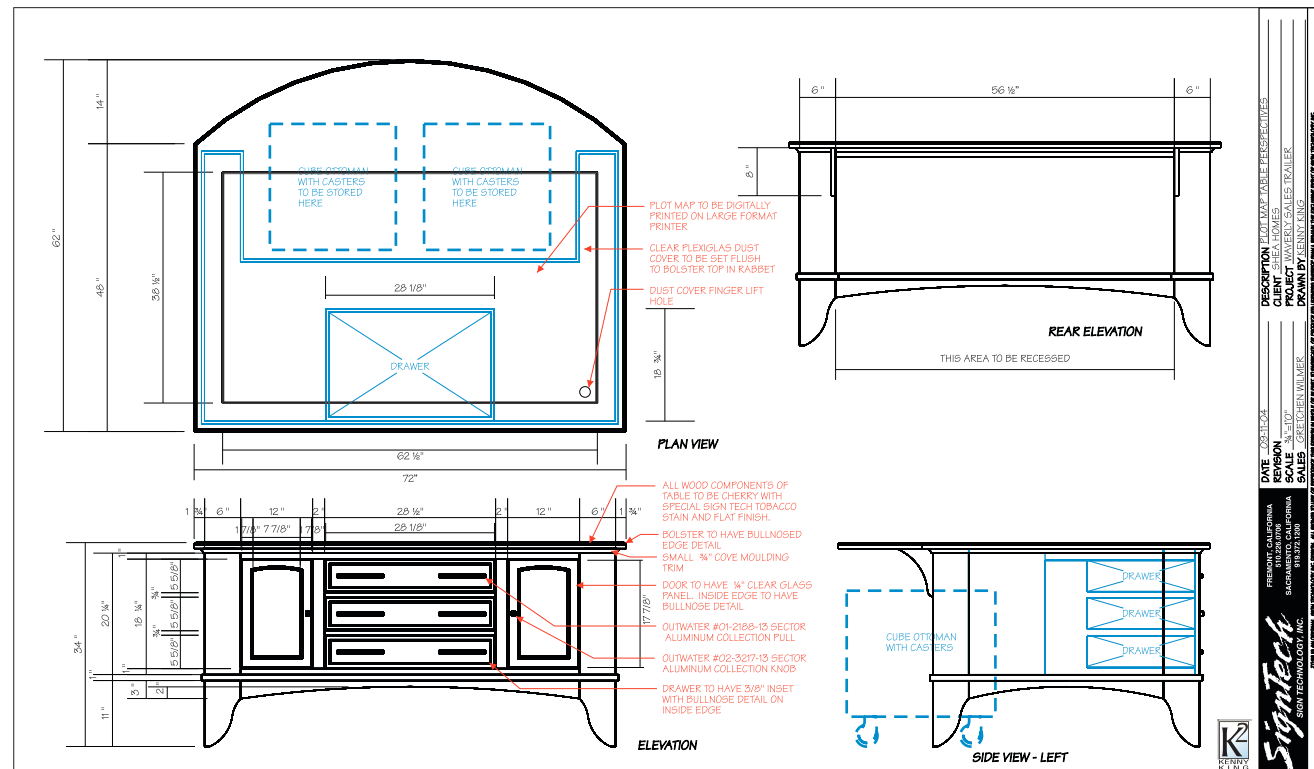

DISPLAYS

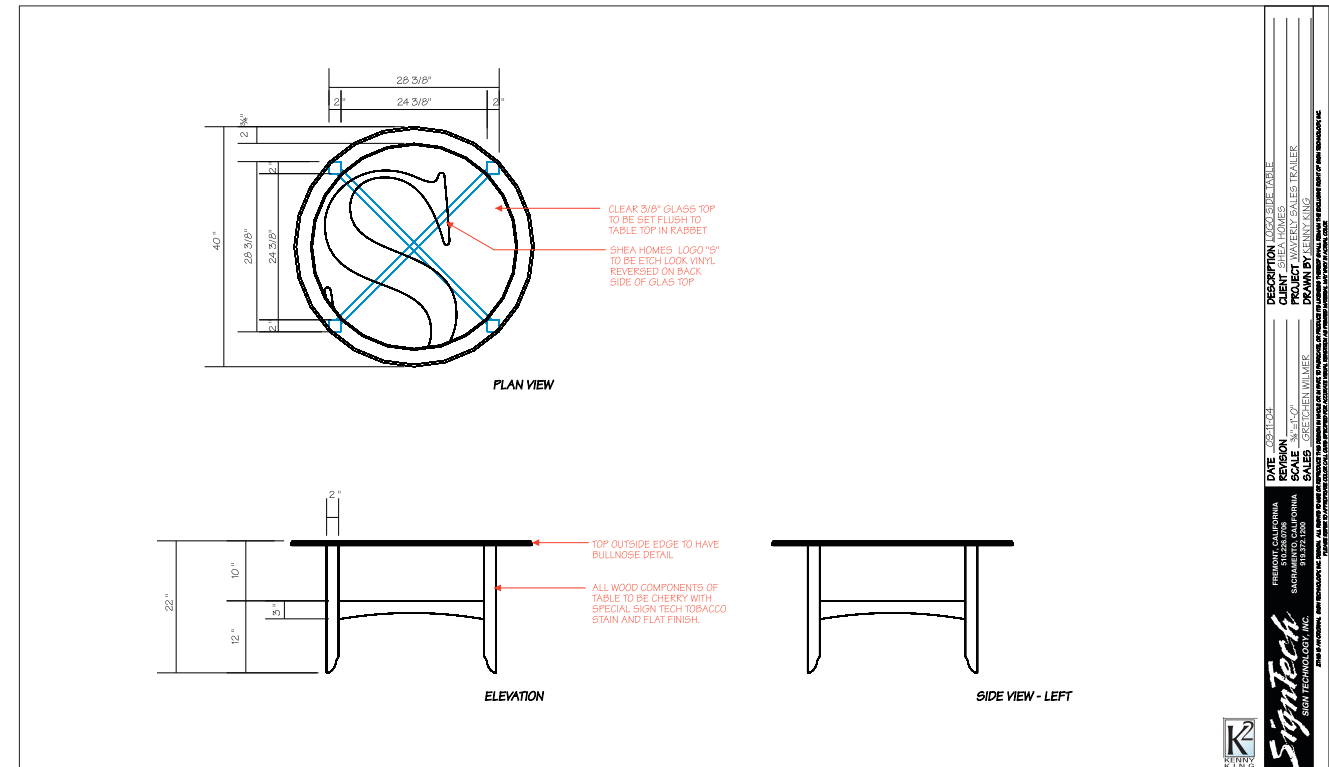
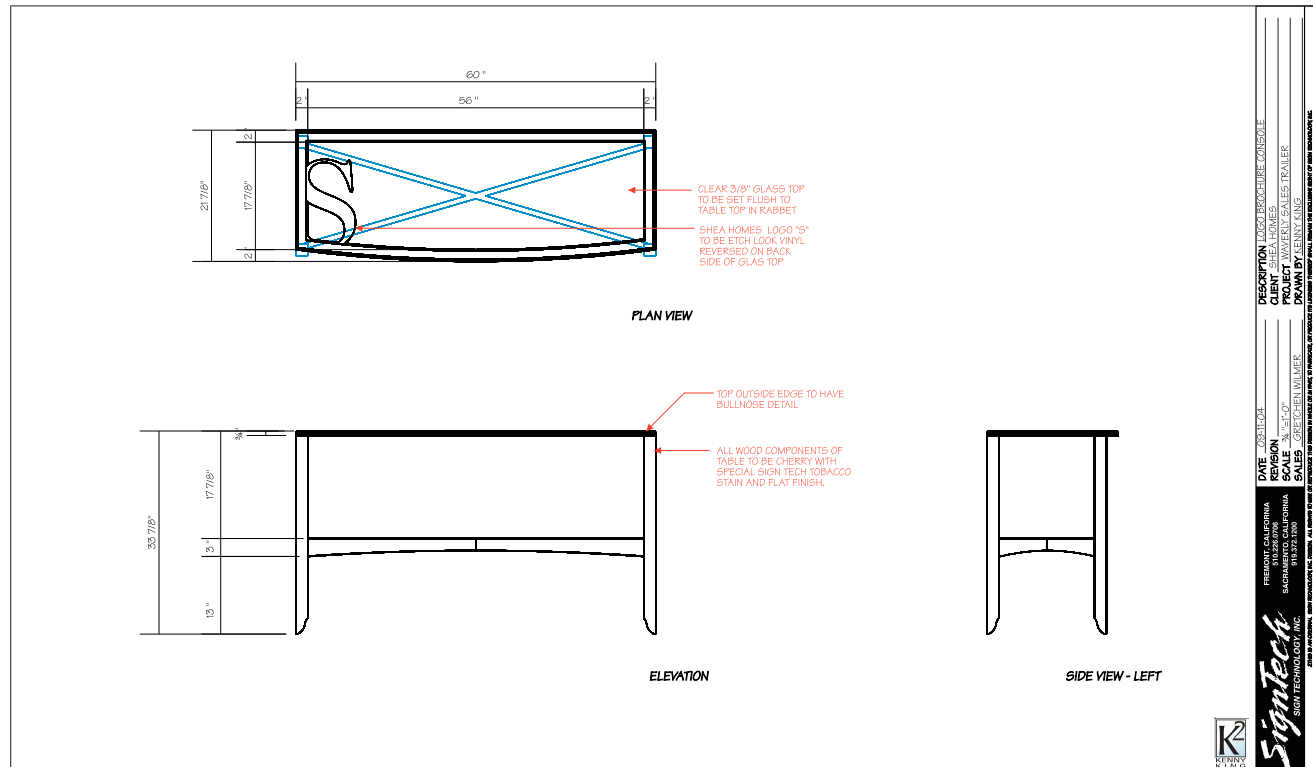
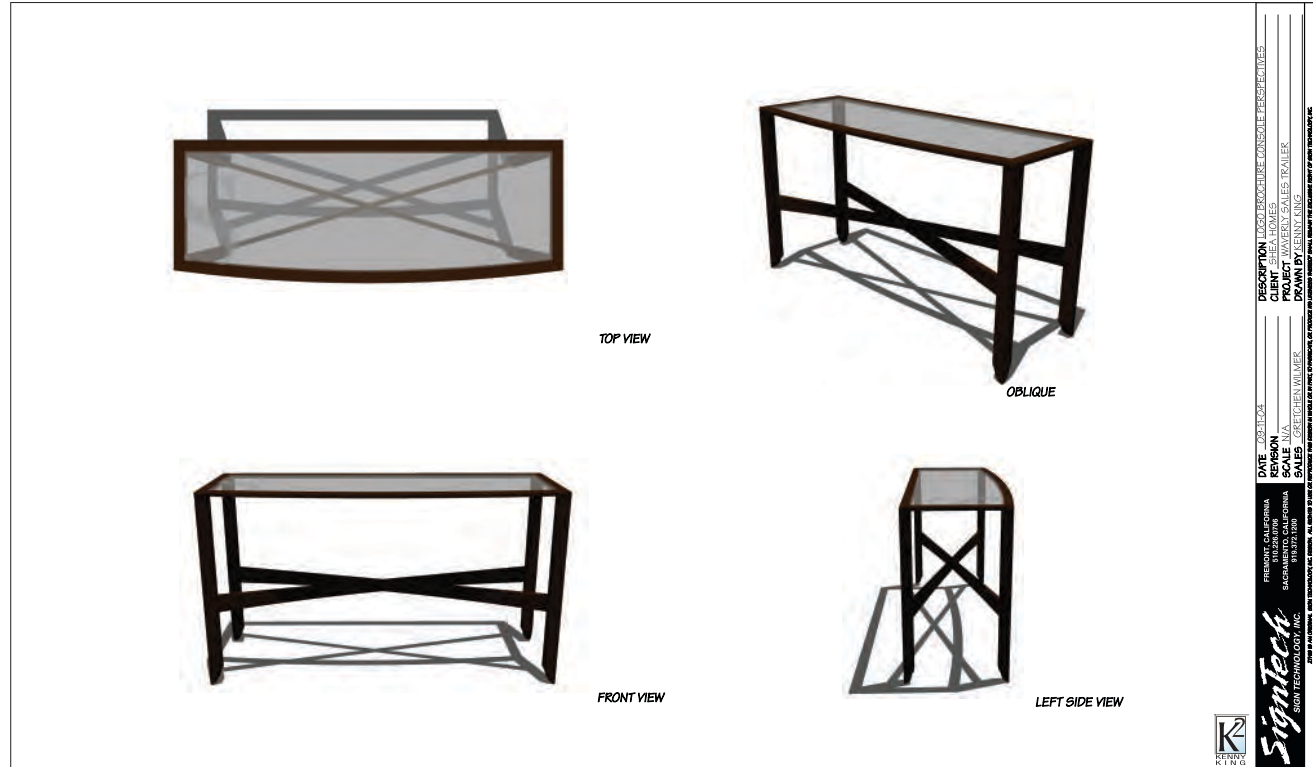

CURVED GRAPHIC WALL

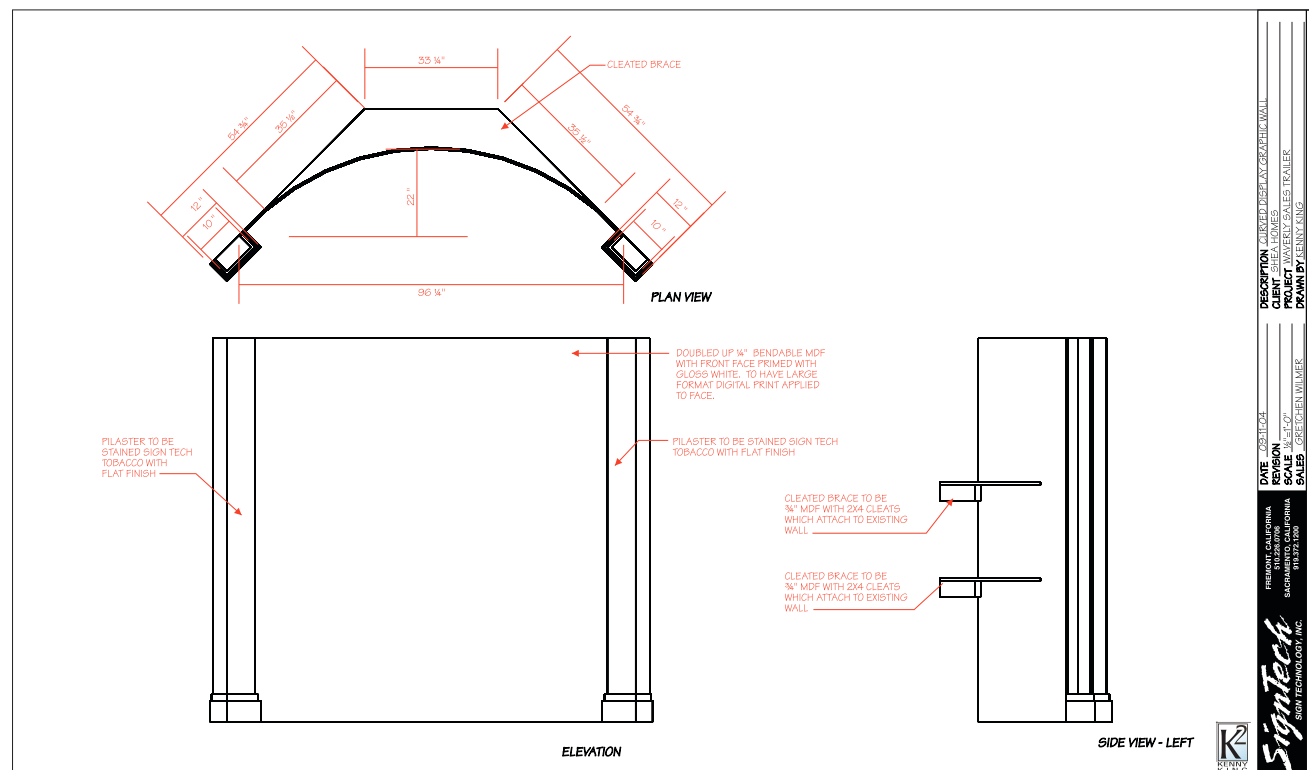
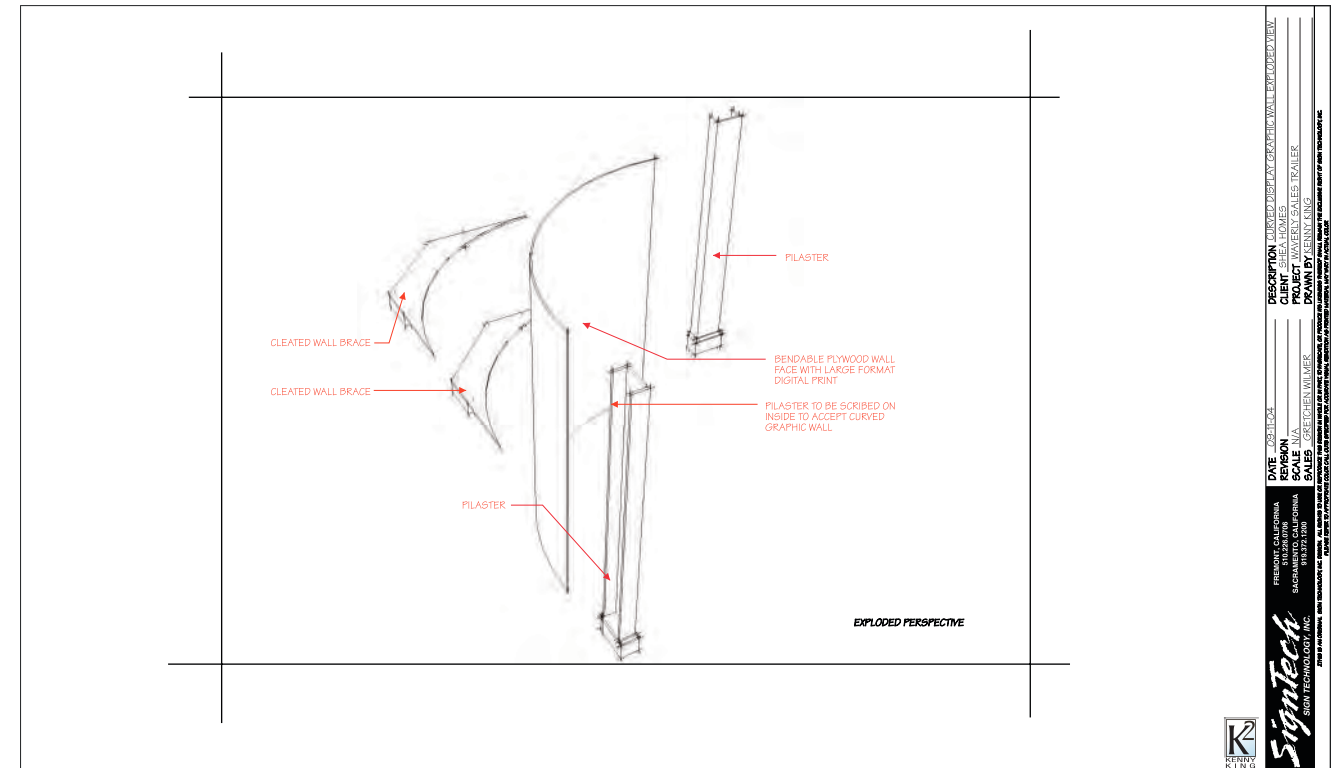
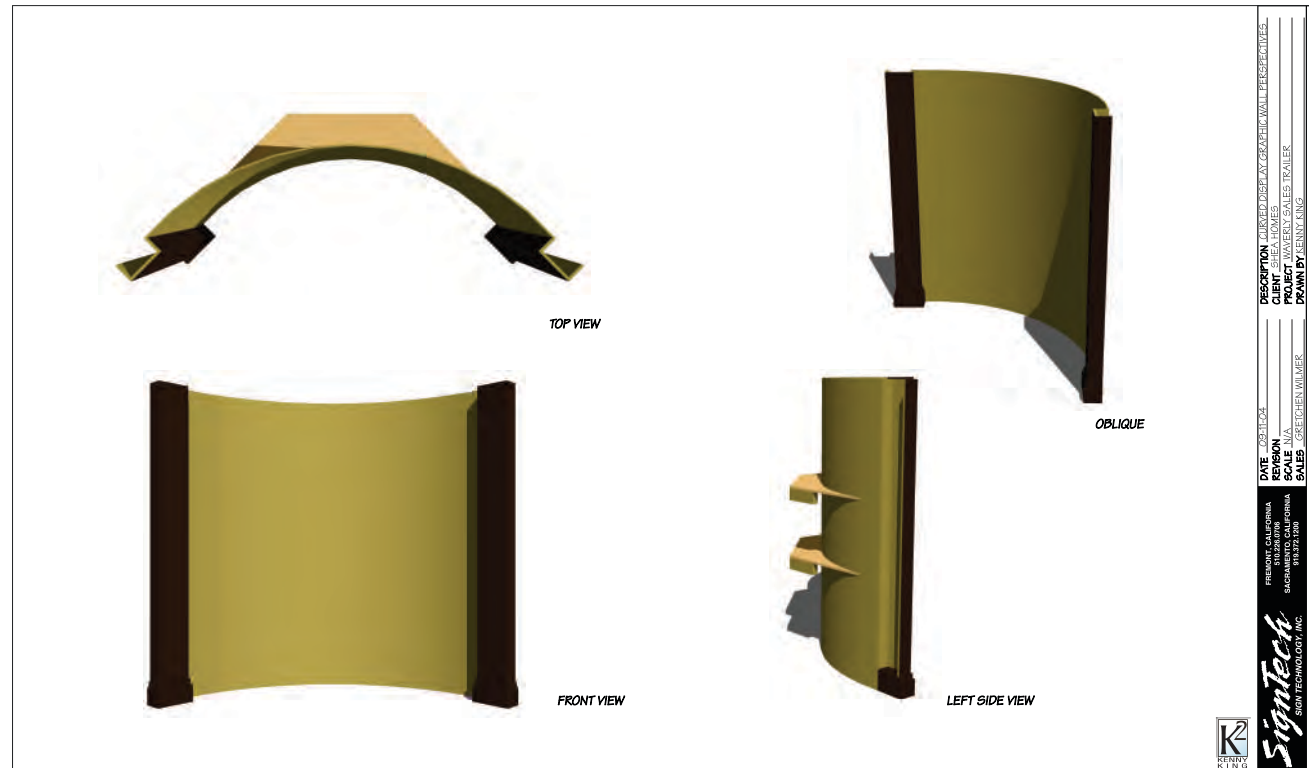

SignTech
 SIGN TECHNOLOGY, INC.

JOB: WAVERLY SALES TRAILER
 CLIENT: SHEA HOMES

GRAPHICS

CURVED WALL GRAPHICS



CORPORATE GRAPHIC



AERIAL MAP



PLOT MAP GRAPHIC



CORPORATE GRAPHIC



IMPACT GRAPHIC



SignTech
SIGN TECHNOLOGY, INC.

JOB: WAVERLY SALES TRAILER
CLIENT: SHEA HOMES

SALES CENTER SIGNS AND BRANDING

SALES CENTER SIGNAGE



SALES CENTER MONUMENT

WALL MOUNTED MODEL HOME IDENTIFICATION SIGN



CORPORATE BRANDING ITEMS



DESKTOP LOGO AND AWARD

BRANDING/CORPORATE GRAPHIC STAND



FLOOR PLAN BOOK WITH ZINC LOGO PLATE INSET INTO COVER

SignTech
SIGN TECHNOLOGY, INC.

JOB: WAVERLY SALES TRAILER
CLIENT: SHEA HOMES